

**LOW-LEVEL POWER MEASUREMENT
TECHNIQUES AND ACCURACY**

STEVE WHITACRE ♦ DEE HUMPHERYS

**RF & Microwave
Measurement
Symposium
and
Exhibition**

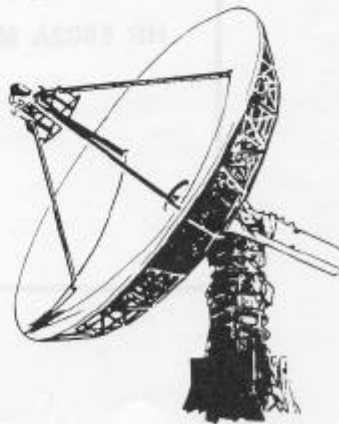

LOW-LEVEL POWER MEASUREMENT TECHNIQUES AND ACCURACY

AGENDA

- 1. Power Measurement Techniques**
- 2. Range/Accuracy Considerations**
- 3. Measurement Example**
- 4. Mismatch Uncertainty**
- 5. Attenuation Measurements**
- 6. Extended Frequency Range**

1236

**Low Level Power Measurement
Techniques and Accuracy
HP 8902A Measuring Receiver**



1206B

Low Level Measurement Techniques

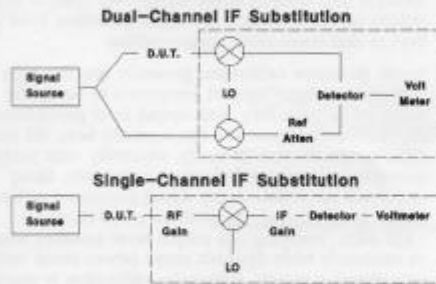

1207

IF Substitution

Limitation	Solution
* Gain Accuracy	Precision High Stability Gain Elements
* Mixer Compression	RF Attenuator (Calibration Required)
* Noise	Low-Noise Preamp Narrow Band Detector
* Linearity	Synchronous Detector
* Signal Instability	Tracking Detector

1238

Slide 4

Two popular methods are single-channel and dual-channel IF substitution. Both methods require linear mixing in the down-conversion stage, accurate IF gain, and linear detection.

Dual-channel IF substitution depends on an IF reference attenuator in a second parallel channel to the DUT. The detector does not need to operate over a wide dynamic range since the reference attenuator is adjusted so the signal level from the DUT compares to the signal level from the reference attenuator. Dual-channel IF substitution can only be used to make relative power measurements.

Single-channel IF substitution is the easiest technique to implement. Instruments that use single-channel IF substitution are basically superheterodyne receivers with a very precise IF gain stage and very linear detectors. Single-channel IF substitution can make extremely accurate relative power measurements over a wide dynamic range and, when calibrated with a power reference, can also make wide dynamic range absolute power measurements.

The combination of a power meter and IF substitution gives the widest range of accurate absolute power measurement capability.

Slide 5

The process of down conversion and IF gain substitution can introduce significant accuracy errors, summarized here.

With proper design, it is possible to reduce these errors to a small fraction of the total measurement error.

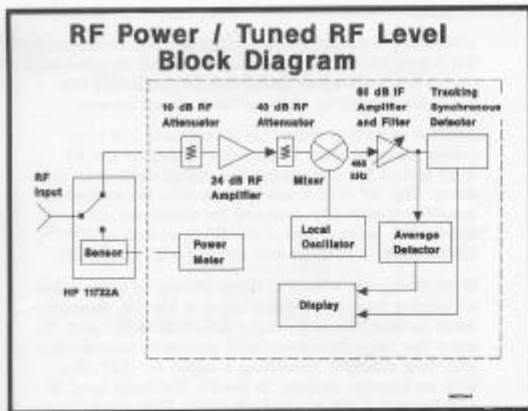

1208

Slide 6

Both a power meter and a single-channel IF substitution receiver are implemented in the HP 8902A Measuring Receiver. By a process of internal calibrations, the best features of both techniques are available as one function mode called "Tuned RF Level." The HP 11722A Sensor Module includes a thermocouple power sensor and an RF switch to allow a single input connector.

A single down-conversion to an IF of 455 kHz allows use of precision components and electronic switching. As a result, a high degree of accuracy in the 10 dB IF gain steps was possible without the need for expensive, elaborate attenuation standards.

Since the range of the input signal is much greater than the linear range of the mixer and IF detector, various combinations of RF and IF gain are selected to adjust the IF signal level into the detector's most linear range, while avoiding mixer overload.

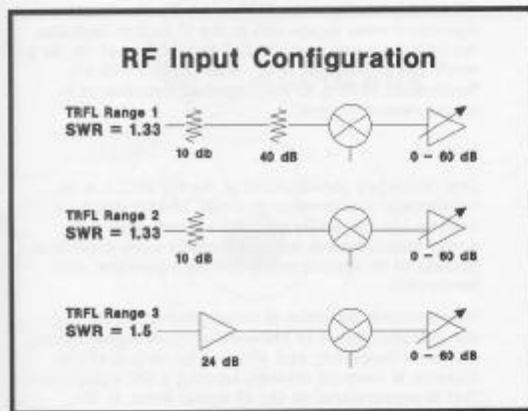

1239A

Slide 7

Depending on the input signal level, three different overlapping RF ranges can be selected. Tuned RF Level (TRFL) range 1 corresponds to 50 dB of attenuation, TRFL range 2 corresponds to 10 dB of attenuation, and TRFL range 3 corresponds to 24 dB of gain. In each RF range, 60 dB of IF gain is available in 10 dB steps.

The overlapping RF Power and TRFL RF ranges allows for cross-calibration between ranges. This calibration information is used to achieve absolute calibration to the 0 dBm reference.



Slide 8

This is the HP 8902A Measuring Receiver. Using the TRFL function, the level of an RF signal can be measured from 0 dBm to -127 dBm with typical linearity better than 0.5 dB (rms) over the frequency range of 2.5 MHz to 1300 MHz.

The combination of the RF Power and TRFL modes allows the HP 8902A to measure absolute power with 157 dB dynamic range.

With the HP 11722A, the RF Power function can measure power from +30 dBm to -20 dBm at frequencies from 100 kHz to 2.6 GHz with accuracy equal to or better than the HP 436A Power Meter. The HP 8902A also accepts all the 8480 series power sensors.

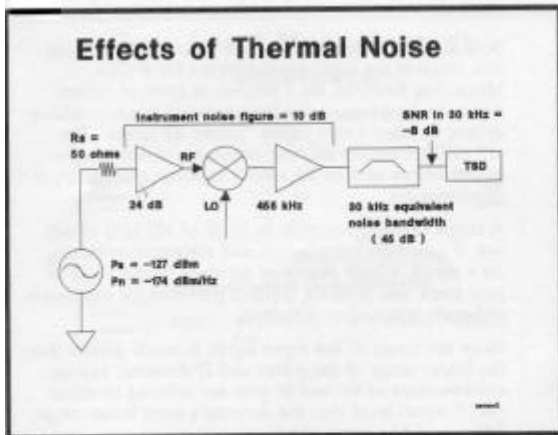

Slide 9

Measuring low level power accurately is complicated by the degradation of the predetection signal-to-noise ratio due to thermal noise. This is one of the factors that limits the sensitivity of broadband power sensors.

Another source of noise that complicates low level power measurements is the noise added by the RF front end of the instrument and image noise from the mixer. The HP 8902A uses a thick-film microcircuit RF amplifier specifically designed for minimum noise figure. The noise figure of the RF front end of the HP 8902A is <10 dB (when using the RF amplifier).

Overcoming the effects of these sources of noise when measuring low level signals requires narrow measurement bandwidths and unique detection techniques. To show the need for narrowband detection, consider the following example measuring a signal at -127 dBm with an average detector in the IF. The basic level of kTB thermal noise is -174 dBm/Hz. This results in an input signal-to-noise (SNR) of 47 dB in a 1 Hz bandwidth (174-127). The 10 dB noise figure of the HP 8902A decreases the SNR to 37 dB. The 30 kHz equivalent noise bandwidth in the IF further decreases the SNR by a value of $10 \cdot \text{LOG}(30 \text{ kHz})$ or 45 dB. As a result, the SNR in the IF is -8 dB (174-127-10-45). Because the SNR is so low, standard detection techniques cannot be used.

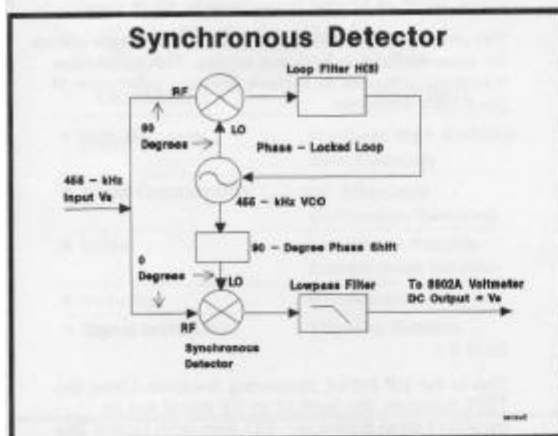

Slide 10

One of the key contributions of the HP 8902A is its narrowband synchronous detector. The synchronous detector has the ability to make accurate low level power measurements under extremely noisy conditions because of its approximately 200 Hz equivalent noise bandwidth.

Synchronous detection is accomplished by mixing the IF signal down to DC with another signal having the same frequency and phase. The output of the detector is lowpass filtered, leaving a DC component that is proportional to the IF signal level. If the input signal happens to be amplitude modulated, the demodulated audio will also appear at the output of the synchronous detector.

Most of the detector's circuitry is used to generate the high-level LO input signal required by the mixer. This signal must be in phase with the input signal and must be capable of tracking an input that may be drifting over several kHz. In order to accomplish this, the VCO that generates the LO signal is phase locked to the input signal which causes the LO signal to be in phase quadrature with the input signal. In order to create the proper zero-degree phase relationship between the LO and the input signal, the output of the VCO is phase shifted by 90 degrees.

One problem associated with the design of the PLL phase detector is that the equivalent loop bandwidth is proportional to the input signal level. As the level of the signal decreases, the bandwidth decreases, causing more of the signal's spectral energy to fall outside of the loop bandwidth (and vice versa). This causes nonlinearities in the detector's DC output.

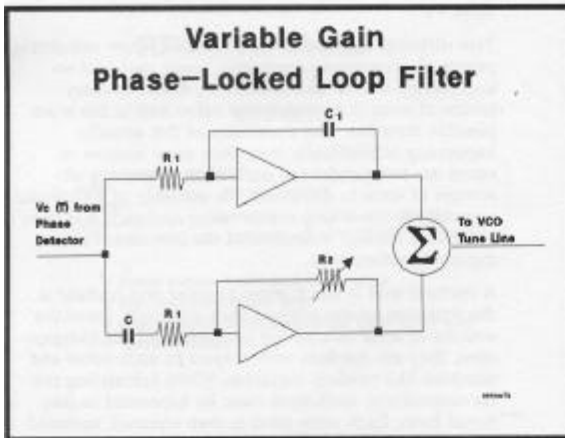

1211

Slide 11

The solution adopted in the HP 8902A to overcome these nonlinearities was to implement a PLL filter with dynamically variable gain. The microprocessor continuously adjusts R2 according to the input signal level to hold the PLL bandwidth constant, thereby eliminating this source of error.

Synchronous detection provides other advantages that are beneficial in making low level measurements in the presence of noise. With synchronous detection, noise adds an AC component to the DC output, in contrast to the multiplicative effect of noise in an envelope detector. As a result, the desired signal can always be recovered through the use of averaging. Output noise can be reduced whenever necessary simply by adding low-pass filtering. Another advantage in using synchronous detection is that only the in-phase noise component is translated to DC - the quadrature component is rejected, which further reduces the effects of noise.

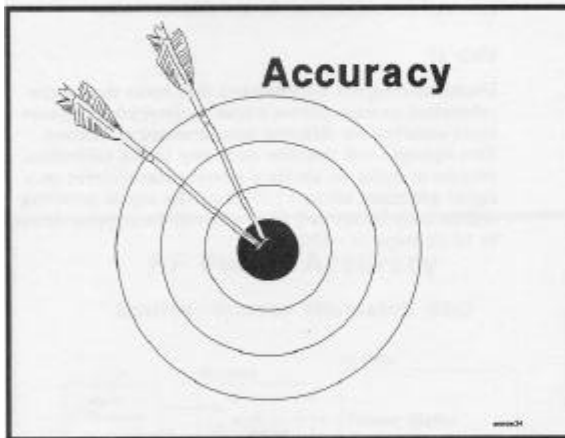

1240A

Slide 12

Accuracy

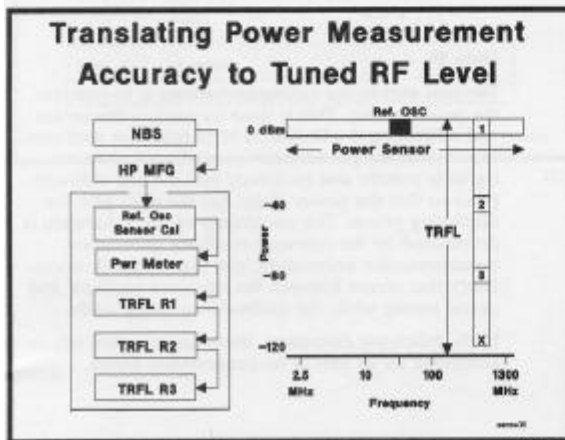

1241A

Slide 13

All power measurement accuracy is based on transferring calibration from one standard to another. This process starts at a primary standard. The HP 8902A power measurement accuracy is derived in exactly this same way. The power meter reference oscillator output and power sensor calibration factors are calibrated against standards traceable to USA National Bureau of Standards. The power reference oscillator is used to calibrate the power meter/power sensor combination. The power meter is then used to accurately measure the level of a signal source. This signal source then becomes the reference oscillator used to calibrate the frequency-dependent uncertainties of Tuned RF Level range 1. TRFL range 2 and range 3 are calibrated similarly. First the source is measured and then used as the reference oscillator to calibrate the next range. In each case the process is the same; 1) determine the power of a signal, 2) use the signal as a reference oscillator to calibrate the next range (of course, the signal amplitude must be held fixed during the calibration process).

Calculating the total uncertainty of this process is simply a matter of determining how accurately the signal source can be measured and how accurately it can be used to calibrate the next range.

Calculating Total Uncertainty

Worst Case Uncertainty

$$e_1 \pm e_2 \pm e_3 \pm \dots \pm e_n$$

Root Sum Square Uncertainty

$$\pm \sqrt{e_1^2 + e_2^2 + e_3^2 \dots + e_n^2}$$

www7

1214

Slide 14

Two different approaches can be taken when calculating power measurement uncertainty; worst case and rss uncertainty. Worst case uncertainty assumes every source of error is at its extreme value and in the worst possible direction. The possibility of this actually happening is essentially zero since most sources of errors are independent of each other. Summing all sources of error to determine the accuracy of a particular measurement is a very conservative approach and does not give a realistic indication of the instrument's expected performance.

A method that is much more popular and realistic is the root-sum-of-the-squares (rss) approach. Since the sources of error in a power measurement are independent, they are random with respect to each other and combine like random variables. When calculating the rss uncertainty, each term must be expressed in fractional form. Each error term is then squared, summed together, and then the square root taken.

The example that follows will show both the worst case and rss uncertainty for the measurement.

Measurement Example

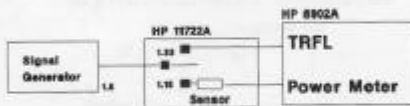

Frequency = 900 MHz
Initial output level = 0 dBm
Final output level = -120 dBm
SWR of source = 1.5

www7

1215

Slide 15

Understanding the uncertainties that occur during the calibration process allows a user to determine measurement accuracy for different measurement conditions. This example will describe each step in the calibration process to make an absolute power measurement on a signal generator set to -120 dBm. The signal generator will initially be set to 0 dBm and will be stepped down in 10 dB steps to -120 dBm.

RF Power Accuracy Power Sensor Calibration 50 MHz

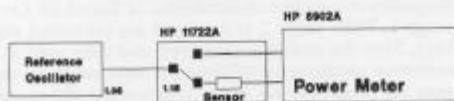

- * Reference Oscillator Uncertainty
- * Instrumentation Uncertainty
- * Mismatch Uncertainty

www7

1216

Slide 16

The first step in the calibration process is to calibrate the power sensor. This is done by zeroing the sensor and calibrating it with the 50 MHz reference oscillator. This causes the power meter to read zero when no signal is present and accurately sets the one milliwatt point so that the power meter has the right gain for displaying power. The uncertainty of this calibration is determined by the reference oscillator uncertainty, instrumentation uncertainty, and the mismatch uncertainty that occurs between the reference oscillator and power sensor while the calibration is being made.

In the following discussion, these uncertainties will be accounted for as part of Instrumentation Errors.

RF Power Accuracy TRFL Range 1 Calibration 900 MHz

- * Power Sensor Calibration Uncertainty
- * Mismatch Uncertainty (Mu)
- * Power Sensor Calibration Factor Uncertainty (Kb)
- * Instrumentation Errors

1217

Slide 17

After the power sensor is calibrated, the HP 11722A Sensor Module is connected to the signal generator, which is set to 0 dBm, and the TRFL function is selected on the HP 8902A. To calibrate the measurement for absolute power, the "CALIBRATE" key is pressed on the front panel of the HP 8902A. The HP 8902A then automatically switches the input signal to the power sensor, takes a reading, switches back to TRFL range 1, takes another reading, then generates a calibration factor for TRFL range 1.

Let's first determine how accurately the output level of the signal generator is measured by the power sensor/power meter combination during this calibration process.

Measuring the output power of the signal generator with the power sensor/power meter combination has the uncertainty of calibrating the power sensor (discussed in the previous slide) plus the mismatch uncertainty between the signal generator and power sensor, power sensor calibration factor uncertainty, and instrumentation uncertainty.

Each source of error in making the power meter measurement will now be determined. The mismatch uncertainty and power sensor calibration factor uncertainty will be determined first, then the various instrumentation errors that affect the power meter accuracy will be determined. All specifications are taken directly from the HP 8902A Technical Data Sheet (November 1985).

RF Power Accuracy Source-Sensor Mismatch (Mu)

SWR of the HP 11722A = 1.15 SWR of the source = 1.5

$$\rho^2 = \frac{(1.15-1)^2}{(1.15+1)^2} = 0.0608$$

$$\rho_g = \frac{(1.5-1)^2}{(1.5+1)^2} = 0.2$$

Error	Description	dB	
		+	-
Mu	20 Log (1 ± ρg ρ)	0.1204	0.1221

1218

Slide 18

The mismatch uncertainty is generally the single largest source of error. For this example, the mismatch uncertainty between the signal generator and power sensor will effect the determination of accuracy by approximately ±0.12 dB. To simplify the calculation of accuracy for this example, it is assumed that the complex impedance of the signal generator remains constant over its entire output level range to -120 dBm. If the source impedance remains constant, the only mismatch that affects the measurement is between the source and power sensor. The mismatch uncertainty between the source and TRFL is eliminated in the calibration process.

Additional mismatch uncertainty terms must be accounted for if the impedance does change during the measurement, which is generally the case. The various sources of mismatch will be discussed after this section.

RF Power Accuracy

Calibration Factor Uncertainty (Kb)

Freq. MHz	RSS Uncertainty	Worst Case Uncertainty
0.1	0.7%	1.6%
0.3	0.7%	1.6%
1.0	0.6%	1.7%
3.0	0.6%	1.7%
10.0	0.6%	2.0%
30.0	0.6%	2.0%
50.0	0.6% Ref.	0.6% Ref.
100.0	1.1%	2.2%
300.0	1.1%	2.2%
1000.0	1.1%	2.2%
2000.0	1.2%	2.3%

Error	Description	dB	
		+	-
Kb Uncertainty	± 2.2% (worst case)	0.0060	0.0046
	± 1.1% (rss)	0.0480	0.0475

1219

Slide 19

This table of power sensor calibration uncertainties is from the HP 8902A Technical Data Sheet. The frequency dependent calibration factors (Kb) compensate for the effective efficiency and mismatch loss of the power sensor. The cal factor uncertainty is due to inaccuracies in the measurement of Kb by the manufacturer or standards laboratories. For this example, the signal generator is set to 900 MHz. At 900 MHz, the rss cal factor uncertainty is 1.1%.

- ### RF Power Specifications
- Instrumentation Errors (Magnification)
- Ref OSC Accuracy :
 - ± 1.2% Worst Case
 - ± 0.6% RSS
 - RF Range Linearity:
 - ± 0.02 dB, RF Range 2 and 5
 - ± 0.08 dB, RF Range 1
 - ± 1 Count of L.S.D
 - RF Range-to-Range Change Error:
 - ± 0.02 dB/RF Range Change from Reference Range
 - Power Sensor Linearity:
 - + 2%, -4%; +30 dBm to +20 dBm
 - Negligible Deviation, Levels < +20 dBm
 - SWR Reference Oscillator: 1.06
 - SWR Power Sensor: 1.15

1220

Slide 20

Now that the mismatch and power sensor cal factor uncertainty have been determined, the instrumentation errors will be determined.

This is a partial list of the specifications, taken from the data sheet, that are necessary to determine the instrumentation errors that affect the accuracy of the power meter/power combination. The specifications for the power meter can be divided into two categories, magnification and offset errors. Magnification errors combine like the gain of amplifiers in cascade and are generally specified as a function of reading (versus a function of full scale). Offset errors are described in the next slide.

The specifications describe the accuracy of the reference oscillator, RF range linearity, RF range change errors, power sensor linearity, and SWR of both the reference oscillator and power sensor. The RF range change errors described here are for the power meter and should not be confused with the RF range change errors for TRFL, which is a separate specification.

- ### RF Power Specifications
- Instrumentation Errors (Offset)
- Zero Set:
 - ± 0.07% of full scale on lowest range.
 - Decrease by a factor of 10 for each higher range.
 - Zero Drift of Meter:
 - ± 0.03% of full scale / °C on lowest range.
 - Decrease by a factor of 10 for each higher range.
 - Zero Drift of Sensor:
 - ± 0.1% of full scale.
 - Decrease by a factor of 10 for each higher range.
 - Noise: ± 0.13% of full scale (for range 2)

1221

Slide 21

This is a summary of the specifications that are considered offset errors. Offset errors combine like voltage generators in series and are generally specified as a function of full scale (versus a function of reading).

Since these errors are a function of full scale, it is important to know which RF Power range was used to make the measurement (this can easily be determined using the SPCL key on the HP 8902A; see the operating manual for more information).

Now that the various sources of instrumentation error have been summarized, the accuracy of the power meter measurement can now be calculated.

RF Power Accuracy Instrumentation Errors (Magnification)

Error	Description	dB		RSS $\Delta X / X$
		+	-	
Ref Osc Accuracy	$\pm 1.2\%$	0.0024	0.0018	.012
RF Range Linearity	RF Level Constant	---	---	---
± 1 Count	± 0.01 dB	0.01	0.01	.0020
RF Range-to-Range	No Range Change	---	---	---
Power Sensor Linearity	Level $< +20$ dBm	---	---	---
Ref Osc Mismatch	SWR _{in} = 1.05, SWR _{out} = 1.15	0.0149	0.0149	.0034
Worst Case Uncertainty		0.0772	0.0766	
RSS Uncertainty		0.0547	0.0554	1.27%

1222

Slide 22

This is a summary of the instrumentation errors (magnification) that affect the accuracy of the power meter measurement (offset errors will be summarized in the next slide).

When performing the calibration process, the power meter only measures the output level of the signal source at one level, which is 0 dBm for this example. This eliminates RF range-to-range change errors, power sensor linearity, and RF range linearity errors. The only magnification errors that affect the accuracy of the measurement are reference oscillator accuracy, reference oscillator mismatch uncertainty, and plus and minus one display digit. The reference oscillator mismatch uncertainty is between the power reference oscillator output and the power sensor.

The RF Power magnification error is $\pm 1.27\%$ (rss). This equates to approximately ± 0.055 dB (rss).

RF Power Accuracy Instrumentation Errors (Offset)

Error	Description	dB		RSS $\Delta X / X$
		+	-	
Zero Set	$\pm 0.007\%$ of F.S.			.00007
Zero Drift - Meter	$\pm 0.003\%$ of F.S.			.00003
Zero Drift - Sensor	$\pm 0.01\%$ of F.S.			.0001
Noise (Range 2)	$\pm 0.13\%$ of F.S.			.0013
	F.S. = Full Scale			
Worst Case Uncertainty		0.0065	0.0065	
RSS Uncertainty				0.13%

1223

Slide 23

This is a summary of the instrumentation errors (offset) that affect the accuracy of the power measurement. To calculate the fractional offset error (required to rss), first determine the full scale power for the RF Power Range used to make the measurement and then calculate the individual offset errors as a fraction of the power measurement.

Then:

$$\frac{\Delta X}{X} = \text{fractional offset error}$$

$$\frac{\Delta X}{X} = \frac{(\% \text{ of F.S.}) (Pfs)}{Pm}$$

F.S. = full scale
Pfs = full scale power
Pm = measured power

For this example, RF Power Range 2 was used to make the measurement at 0 dBm (1 mW). Full scale power for range 2 is also 1 mW so the fractional component used to rss the offset errors is just the fractional specification. The rss offset error for this example is 0.13%.

To calculate the contribution in dB, the total offset error must first be determined. For this example, the total offset is $1.5 \mu\text{W}$ ($0.07 \mu\text{W} + 0.03 \mu\text{W} + 0.1 \mu\text{W} + 1.3 \mu\text{W}$). The dB contribution, which is ± 0.0065 dB for this example, is calculated from:

$$t_{dB} = 10 \text{ Log} \left(1 \pm \frac{t}{Pm} \right)$$

The total power meter measurement uncertainty can now be summarized.

Slide 24

This is the total uncertainty when measuring the output power of the signal generator, set to 0 dBm, with the power meter (HP 8902A RF Power function). It includes the mismatch uncertainty between the signal generator and power sensor, power sensor cal factor uncertainty, and instrumentation error. The total power measurement uncertainty is 3.26% (rss). This equates to ± 0.14 dB (rss).

Total RF Power Accuracy (Mu, Kb, Instrumentation) 0 dBm 900 MHz

Error	Description	dB		RSS $\Delta X / X$
		+	-	
Mu	$20 \text{ Log}(1 + \rho_{gp})$	0.1204	0.1221	.0279
Kb Uncertainty	3.2% (wc)	0.0066	0.0040	
	1.7% (rss)			.001
Inst Uncertainty	Magnification (wc)	0.0772	0.0768	
	(rss)			.0127
Inst Uncertainty	Offset (wc)	0.0065	0.0065	
	(rss)			.0013
Worst Case Uncertainty		0.3007	0.2997	
RSS Uncertainty		0.1398	0.1409	3.26%

1224

Tuned RF Level Accuracy

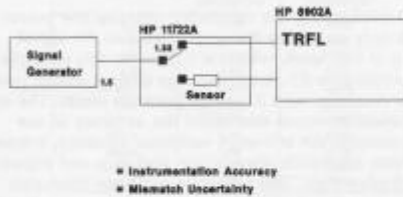

1225

Slide 25

Now that the output level of the signal generator has been accurately measured by the power meter, the calibration process is completed by using it as the reference oscillator and making a measurement with TRFL range 1. The measurement taken with TRFL range 1 is compared to the measurement taken with the power meter. From these two readings, a calibration factor is generated that will make the reading taken with TRFL range 1 compare exactly with the power meter measurement (the calibration process was initiated by pressing the "CALIBRATE" key on the HP 8902A).

The calibration process that's performed compensates for the frequency dependent uncertainties in the RF front end of the TRFL circuitry. These include the RF attenuator and RF amplifier uncertainties, and mixer conversion loss. The calibration process also compensates for the mismatch uncertainty between the signal generator and TRFL range 1 (assuming the complex impedance remains constant from calibration to measurement).

Now that TRFL range 1 is calibrated to the power meter, the signal can be reduced in level until it is necessary to switch to TRFL range 2 to increase its measurement sensitivity (the HP 8902A changes to TRFL range 2 at approximately -40 dBm and to TRFL range 3 at approximately -80 dBm). During a range change, the same calibration process takes place: 1) determine the power of the signal, 2) use the signal as a reference oscillator to calibrate the next range. The only difference in calibrating TRFL range 2 is that TRFL range 1 will determine the power of the signal, not the power meter, as was the case calibrating TRFL range 1.

The instrumentation accuracy using TRFL will now be determined using the specifications from the HP 8902A Technical Data Sheet. It is assumed that the signal generator has been stepped down in level to -120 dBm.

Slide 26

This is a summary of the errors associated with measuring a signal with TRFL. As the signal level is reduced, various combinations of RF and IF gain are selected to keep the signal in the most linear region of the detector. For a particular measurement situation, it's important to keep track of the various states of the HP 8902A so that the an accurate calculation of uncertainty is possible. This can easily be done by using the SPECIAL key to determine the state of the instrument and Special Functions to determine the detectors output voltage (see the operating manual for more information).

Tuned RF Level Specifications

Instrumentation Errors

- Synchronous Detector Linearity:
 ± 0.007 dB/dB Change but not more than 0.02 dB/70 dB Change
- IF Range-to-Range Error:
 ± 0.02 dB/10 dB
- RF Range-to-Range Error:
 ± 0.04 dB/RF Range Change
 ± 0.06 dB/RF Power to TRFL
- Frequency Drift Error:
 ± 0.06 dB/Hz Freq Drift from Center of IF
- Noise Error:
 ± 0.18 dB for Levels < -120 dBm

1226

Tuned RF Level Accuracy

Instrumentation Errors

Error	Description	dB		RSS % X / X
		+	-	
Detector Linearity	± 0.02 dB	0.02	0.02	.0048
IF Range Changes	± 12*0.02 dB (wo) ± 2* (4*(0.0048) ²) ^{0.5} (rss)	0.24	0.24	0.0278
PM to TRFL R1	± 0.06 dB	0.06	0.06	.0138
TRFL R1 to TRFL R2	± 0.04 dB	0.04	0.04	.0092
TRFL R2 to TRFL R3	± 0.04 dB	0.04	0.04	.0092
Worst Case Uncertainty		0.4000	0.4000	
RSS Uncertainty		0.1444	0.1488	3.38%

1227

Slide 27

As the level from the signal generator is reduced from 0 to -120 dBm, instrument errors affect the accuracy of the TRFL measurement (as they did using the power meter measurement). These sources of error include detector linearity, IF and RF range-to-range change errors, frequency drift error, and noise. For this measurement example, it is assumed that the voltage to the detector varied 3 dB, there were twelve IF range changes, and three RF range changes (RF power to TRFL1, TRFL1 to TRFL2, and TRFL2 to TRFL3). It is also assumed that the signal did not drift, so there is no frequency drift error.

When calculating the IF range-to-range rssi uncertainty, the IF range changes for each RF range must first be rssi'd together because each IF range error is independent of each other. The IF gain uncertainty for each RF range is then added together, not rssi'd since each IF gain stage repeats for each RF range, making them dependent errors.

For this example, the total rssi uncertainty for Tuned RF Level is ± 3.38%. This equates to approximately ± 0.14 dB.

Total Measurement Uncertainty

RF Power and TRFL

Constant Source Impedance Over 120 dB Range

Error	Description	dB		RSS % X / X
		+	-	
RF Power	Worst Case	0.2007	0.2987	
	RSS	0.1938	0.1488	.5528
Tuned RF Level	Worst Case	0.4000	0.4000	
	RSS	0.1444	0.1488	.3338
Worst Case Uncertainty		0.7007	0.6987	
RSS Uncertainty		0.1888	0.2088	4.70%

1228

Slide 28

The rssi uncertainty in measuring a signal generator with SWR of 1.5 at an output level of -120 dBm is ± 4.70%. This equates to approximately ± 0.2 dB.

Now that the accuracy of measuring a signal at -120 dBm has been determined, a typical graph of the uncertainty in measuring an HP 8640B Signal Generator is shown.

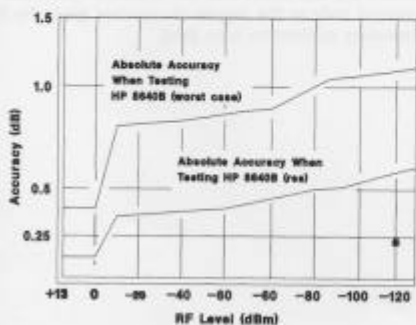

1229

Slide 29

This graph shows the absolute and relative power measurement accuracy measuring the output level of an HP 8640B. The curves show higher uncertainty than our example because we assumed a nonvariant source impedance, which is not valid.

Calculating the uncertainty in making a level measurement is fairly straight forward when only the instrumentation errors are considered. The calculation is complicated by the mismatch uncertainty, especially when the complex impedance of both the analyzer and source are changing. Let's now see how the various sources of mismatch can affect the accuracy of a power measurement.

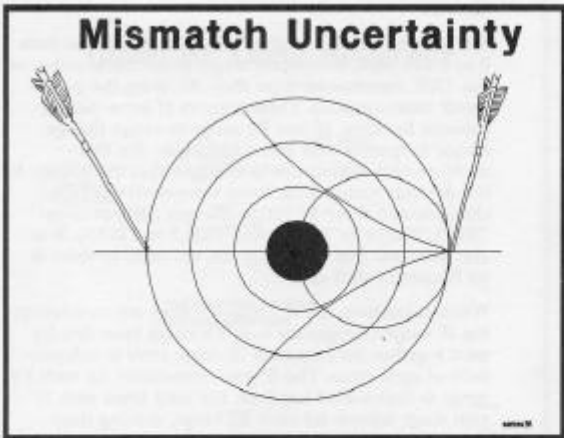

1242A

Slide 30
Mismatch Uncertainty

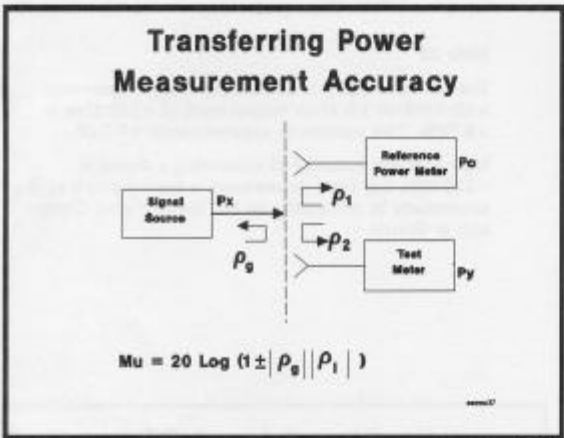

1243A

Slide 31
As previously described, power measurement accuracy is based on transferring calibration from one standard to another. To show the effects of mismatch when transferring power measurement accuracy, consider a system consisting of a signal source with output impedance ρ_g , a reference power with input impedance ρ_1 , and a test meter with input impedance ρ_2 .

Calibration Uncertainty

Reference Meter	Test Meter
$P_o = \frac{P_x}{(1 - \rho_g \rho_1)^2}$	$P_y = \frac{k P_x}{(1 - \rho_g \rho_2)^2}$
$k = \left[\frac{(1 \pm \rho_g \rho_2)^2}{(1 \pm \rho_g \rho_1)^2} \right] \frac{P_y}{P_o} = [Mc] \frac{P_y}{P_o}$	

1244A

Slide 32
The impedances are vector quantities but only their magnitudes are known. The calibration constant, k , between the test meter and the reference meter can be measured only to the degree of accuracy given by the uncertainty calibration term $[Mc]$.

Mismatch Uncertainties

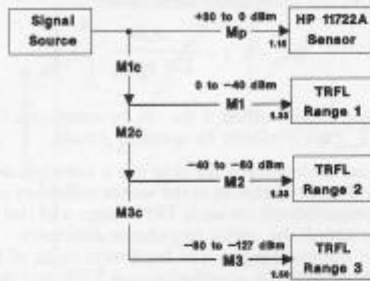

1245A

Slide 33

When making low-level power measurements using the range-to-range calibration technique previously discussed, the impedance mismatches are considered as given in the example. One mismatch uncertainty that exists between the power reference oscillator and the power sensor (when calibrating the sensor) was previously included as an instrumentation error term and will not be considered here. The definitions are:

M_p, M_1, M_2, M_3 — mismatch between source and power sensor, range 1, 2, or 3 when making a measurement on that particular range.

M_{1c}, M_{2c}, M_{3c} — range calibration uncertainties incurred when that range is calibrated.

During the range-to-range calibration process, the source output level remains constant (the impedance of the source does not change) while the analyzer makes power measurements with both ranges. Since this process is basically a ratio of power measurements, the calibration factor that is generated compensates for any differences in the measured power from one range to the next. This means that the measurement accuracy of the previous range is transferred to the new range, within the accuracy limits of the $[M_c]$ term.

The equation for measuring power at any arbitrary level on Range 1 relative to the first high-level power measurement can now be written as:

$$\frac{P_{R1}}{P_0} = k_1 [M_{1c}] [M_1]; k = \text{calibration constant};$$

and for range 3:

$$\frac{P_{R3}}{P_0} = k_3 [M_{1c}] [M_{2c}] [M_{3c}] [M_3]$$

Typically the power sensor provides the best receiver match and the most sensitive range provides the worst match, since it is generally a low-noise amplifier.

Our purpose now will be to examine the magnitude of these errors and ways to reduce or eliminate them.

Measuring Range-to-Range Calibration Uncertainties

$$\vec{\rho}_n = \vec{\rho}_{n-1} + \Delta\vec{\rho}$$

$$\frac{(1 - \vec{\rho}_g \vec{\rho}_n)^2}{(1 - \vec{\rho}_g \vec{\rho}_{n-1})^2} = \frac{(1 - \vec{\rho}_g (\vec{\rho}_{n-1} + \Delta\vec{\rho}))^2}{(1 - \vec{\rho}_g \vec{\rho}_{n-1})^2} = \left[\frac{1 + \vec{\rho}_g \Delta\vec{\rho}}{1 - \vec{\rho}_g \vec{\rho}_{n-1}} \right]^2$$

$$M_{nc} = \left[1 + \frac{\rho_g \Delta \rho}{1 - \rho_g \rho_{n-1}} \right]^2 \quad \text{Scalar Quantities}$$

1763

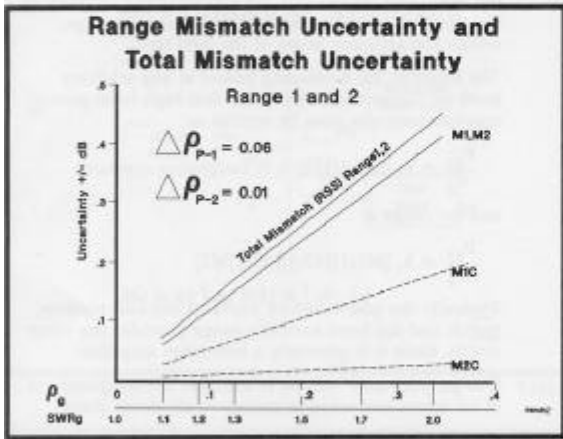

1764

Slide 34

If we write the input impedance of any range in terms of an impedance *change* from the previous range, we can derive the uncertainty term:

$$M_{nc} = \left[1 + \frac{\rho_g \Delta \rho}{1 - \rho_g \rho_{n-1}} \right]^2$$

which can be quantified if $\Delta \rho$ can be measured, since ρ_g and ρ_{n-1} are available as specified values.

A method to determine $\Delta \rho$ is to use a network analyzer such as the HP 8510A to make vector reflection coefficient measurements on each TRFL range and use trace math to obtain the vector impedance difference between the two ranges. The maximum value of this term, along with the specified source SWR and the specified TRFL range SWR, can then be used to calculate range-to-range uncertainty.

Measured values of $\Delta \rho$ are:

- $\Delta \rho_{p-1} = 0.06$ (power meter to TRFL range 1)
- $\Delta \rho_{1-2} = 0.01$ (TRFL range 1 to TRFL range 2)
- $\Delta \rho_{2-3} = 0.25$ (TRFL range 2 to TRFL range 3)

Slide 35

This graph shows the typical range-to-range uncertainty terms (dotted lines) and the measurement uncertainty term for ranges 1 and 2 of the HP 8902A with an HP 11722 Sensor Module. The total mismatch uncertainty is the rss summation of M1C and M1 for range 1, and M1C, M2C and M2 for range 2. Since M2C is so small, its effect is negligible and therefore ranges 1 and 2 have the same total uncertainty. Note that there is very little contribution by the range-to-range calibration terms.

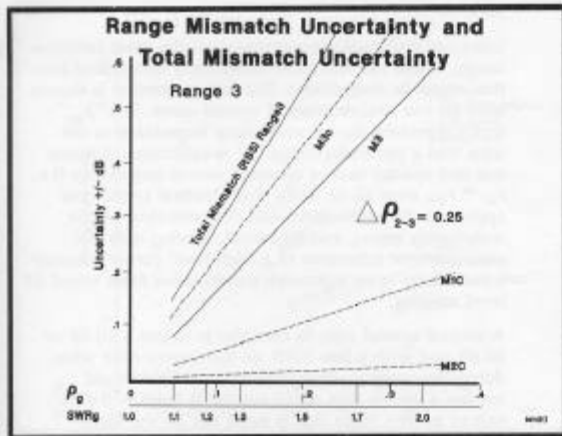

1765

Slide 36

This graph shows the uncertainty terms for range 3. Note that M3C is much larger than the other range-to-range terms because of the significant change in input impedance from range 2 to range 3. Also, on range 3 the input SWR is not as good, so the measurement term M3 is also significantly larger.

As an example of how to use this graph, consider the measurement of a source set to -110 dBm (TRFL range 3) with an SWR of 1.5 ($\rho=0.2$). It is assumed that the complex impedance of the source does not remain constant (the calibration process does not compensate for the mismatch uncertainties). The mismatch uncertainty would then consist of the following terms:

- Sensor to range 1 calibration = ± 0.1 dB (2.3%)
- Range 1 to range 2 calibration = ± 0.02 dB (0.4%)
- Range 2 to range 3 calibration = ± 0.43 dB (10.5%)
- Range 3 measurements = $\pm .35$ dB (8.5%)

To rssi the uncertainties, the linear terms must be squared, summed, then square root taken. This results in an rssi mismatch uncertainty of $\pm 13.7\%$. This equates to approximately ± 0.56 dB.

These graphs are derived on the assumption that there are no restrictions on the source SWR except that its total magnitude is specified. In many instances, source SWR is held fixed over a large part of the dynamic measurement range. It is instructive to examine the total mismatch uncertainty using some special cases that commonly occur.

Lowest Range Mismatch Uncertainty

$$\frac{P_{R3}}{P_o} = k3 [M1c] [M2c] [M3c] [M3]$$

$$\frac{P_{R3}}{P_o} = k3 \left[\frac{(1 \pm \rho_{gc1} \rho_1)^2}{(1 \pm \rho_{gc1} \rho_p)^2} \right] \left[\frac{(1 \pm \rho_{gc2} \rho_2)^2}{(1 \pm \rho_{gc2} \rho_1)^2} \right] \times \left[\frac{(1 \pm \rho_{gc3} \rho_3)^2}{(1 \pm \rho_{gc3} \rho_2)^2} \right] \left[\frac{1}{(1 \pm \rho_{g3} \rho_3)^2} \right]$$

1246A

Slide 37

Consider making a measurement on the most sensitive range, which has the most uncertainty terms (and also the largest in magnitude). The full expression is shown here for our examination of special cases. The " ρ_{gc} " terms represent the source output impedance at the time that a particular range "n" is calibrated. Assume our first special case: a constant source impedance (i.e., $\rho_{gn} = \rho_{gm}$ over all n). Note that identical terms now appear in the numerators and denominators of the uncertainty terms, and all cancel, leaving only the measurement mismatch of a high-level power measurement! There is *no* mismatch contribution from tuned RF level ranging.

A second special case to consider is to use a 10 dB or 20 dB pad with a low SWR on the source only when doing the range-to-range calibration. This would require a source that could supply at least +10 dBm output power. Note that it need not be the same source under test, but it must be at the same frequency. Assuming the pad SWR is substantially better than the SWR of the source under test, the two terms $(1 \pm \rho_{gc} \rho_p)^2$ and $(1 \pm \rho_{gc} \rho_3)^2$ will be negligible compared with $(1 \pm \rho_{g3} \rho_3)^2$ and we again have only one mismatch uncertainty.

A third case to consider is to hold the receiver input impedance, ρ_n , constant over all ranges. In this case, the range-to-range calibration terms are all unity, and, as before, there is only one mismatch term.

Slide 38

This summarizes the situations we have discussed.

Special Cases

Case 1: Constant Source Impedance: ρ_g

$$\frac{P_{R3}}{P_o} = k3 \frac{1}{(1 \pm \rho_g \rho_p)^2} = k3 [M3]$$

Case 2: Constant, Low SWR Source Impedance
During Calibration: $\rho_{gc} \ll \rho_g$

$$\frac{P_{R3}}{P_o} \approx k3 [M3]$$

Case 3: Constant Receiver Impedance: ρ_3

$$\frac{P_{R3}}{P_o} = k3 \frac{1}{(1 \pm \rho_g \rho_3)^2} = k3 [M3]$$

1766

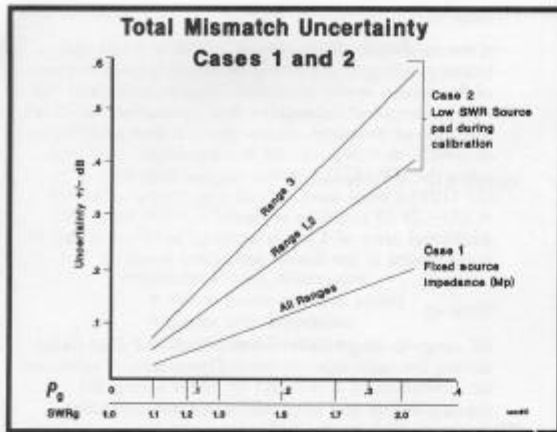

1767

Slide 39

This graph shows the total mismatch uncertainty for special cases 1 and 2. Note that the total mismatch uncertainty is the same as the measurement uncertainty; i.e., there are no contributions from range-to-range calibration! For case 2, the ranges were calibrated with an HP 8491B 10 dB pad with Option 890 (measured SWR data). This pad has a measured SWR < 1.1.

The range 3 total mismatch uncertainty drops from ± 0.54 dB to ± 0.35 dB for a source having an SWR = 1.5.

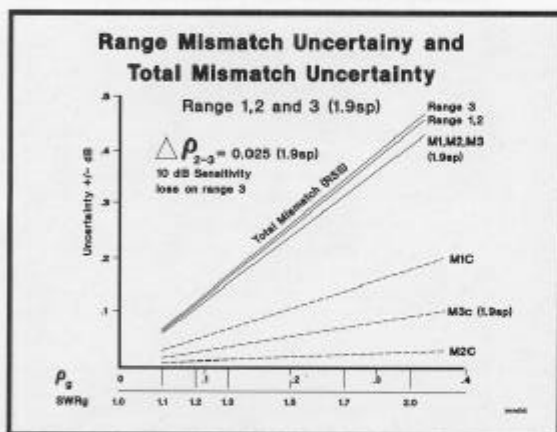

1768

Slide 40

The HP 8902A/11722A has a special keystroke function (1.9SP) that fixes a 10 dB pad at the input of all TRFL ranges. This very closely approximates the fixed receiver special case 3 noted above. This graph shows the range-to-range calibration uncertainties, measurement uncertainties, and total mismatch uncertainties when using this key function. Note the improvement in range 3 total uncertainty. Also note that a 10 dB sensitivity loss is incurred on range 3 only. Operation on ranges 1 and 2 is identical to standard operation.

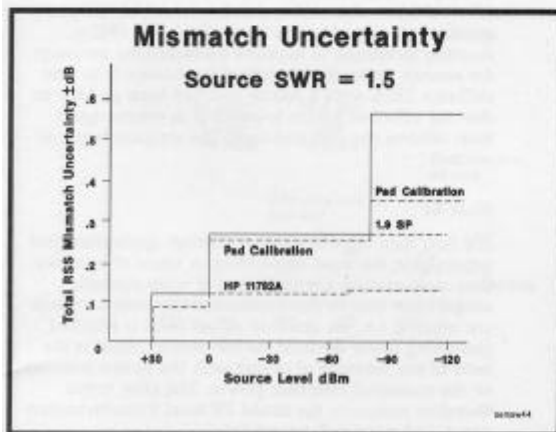

1250A

Slide 41

This graph shows the total mismatch uncertainty (for a source SWR=1.5) over the 157 dB range of the HP 8902A. The improvement is range-to-range calibration by using a pad is clearly evident.

Another power sensor, the HP 11792A covering the 50 MHz-26.5 GHz range, has been developed for use in microwave systems. It incorporates a low SWR 10 dB pad ahead of the sensor-RF path switch. Option 001 has a type-N connector for 50 MHz-18 GHz use, and if this sensor (with its better match) is used over the 50 MHz-1300 MHz range, the mismatch uncertainty can be reduced even further. This, of course, incurs a 10 dB sensitivity loss.

Total Measurement Uncertainty RF Power and TRFL

Error	11722A at -120 dBm		11792A at -117 dBm	
	dB	Δ x/x	dB	Δ x/x
RF Power (over-riding mismatch)	.07	.0088	.07	.0168
Tuned RF Level	.16	.0338	.16	.0338
Mismatch	.35	.0838	.15	.0292
Noise Effects (≤ -120 dBm at HP 8902A input)	-	-	.18	.0423
RRS Uncertainty	.42 dB	$\pm 6.2\%$.29 dB	$\pm 6.4\%$

1251A

Reducing Measurement Uncertainty

- * **RF Range-to-Range Errors**
Increase Averaging
- * **Power Meter Noise**
Avoid Calibrating On Most Sensitive Range
- * **Frequency Drift**
Use a Stable Source
- * **Mismatch Uncertainty**
Pad Both Source and / or Analyzer
1.9 SP
Calibrate with Padded Source

1769

Attenuation Measurements

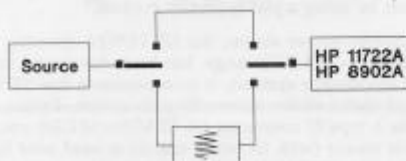

- * Tuned RF level accuracy
- * Mismatch uncertainty

1770

Slide 42

If the mismatch uncertainty of .35 dB at -120 dBm (corresponding to the pad calibration) is used in place of the source sensor mismatch described above in "RF Power Accuracy" (remember that uncertainty of .12 dB assumed an invariant source SWR), a final uncertainty of $\pm 9.2\%$ or $+38/-42$ dB is achieved at -120 dBm, using the HP 11722A power sensor. Had the HP 11792A been used, a final uncertainty of $\pm 6.4\%$ $+27/-29$ dB could be achieved at -117 dBm. (An additional error of 4.2% is required in this case due to noise effects at the lowest sensitivity levels.)

Slide 43

RF range-to-range errors occur because of digit flicker during the calibration process. This source of error can be minimized or eliminated by either noting the reading before and after calibration and correcting future reading by the difference or by increasing averaging time by using the 4.X special functions. Measuring a low noise source inherently minimizes this source of error since the residual noise of the source is the main cause of digit flicker during a TRFL measurement.

Power meter noise, due to sources within both the power sensor and power meter circuitry, becomes significant on the most sensitive range of the sensor. To minimize this source of error, avoid calibrating TRFL range 1 on the most sensitive RF Power range (noise error decreases by a factor of 10 for each higher range).

Frequency drift can cause an error that is no more than ± 0.05 dB/kHz. This source of error is generally not a factor when measuring synthesized signal generators. Any drift that may occur due during warm-up can be eliminated by locking both the source and HP 8902A to a common reference.

The most effective technique for minimizing mismatch uncertainty is to pad both the source and analyzer during a measurement (this should always be done for attenuator measurements unless more dynamic range is needed). The next best technique to pad the HP 8902A to keep its impedance constant by padding the HP 11722A, and/or using 1.9 Special which keeps a constant 10 dB pad at the input of the HP 8902A. Another technique to improve measurement accuracy for sources with varying output impedance is to first calibrate TRFL with a source that has been padded so that the effective source impedance is constant and then remove the pad and make the measurements as normal.

Slide 44

We now turn our attention to another application that generally is the most demanding in terms of accuracy; that of measuring attenuation over wide dynamic range. Note that in this application the measurements are relative, i.e., no absolute power level is required (assuming linear devices), as the desired result is the ratio of the measure of power with the device inserted to the measured reference power. The error terms therefore reduce to the tuned RF level instrumentation errors and mismatch uncertainty.

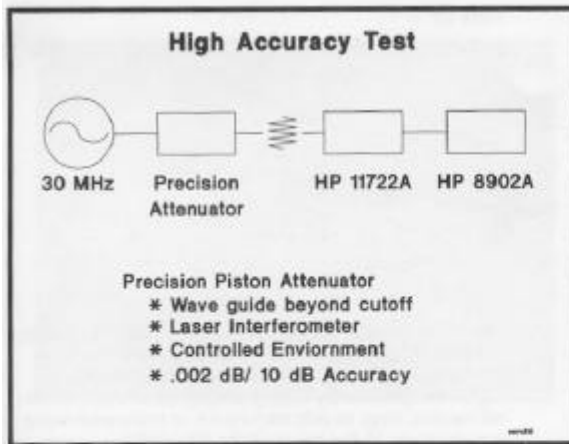

1771

Slide 45

The tuned RF level instrumentation inaccuracies discussed previously were derived by taking into account all possible errors in the manufacturing environment, including the accuracies of the production test systems, which represent the largest contribution to instrumentation error.

A recent addition to that test environment, a precision attenuator, allows the tuned RF level accuracy to be improved to a level significantly better than the standard data sheet figures. This improved specification will be available as an option to the standard HP 8902A.

Because the source impedance as seen by the sensor module never changes, and no connect/disconnect cycles are necessary during this test, there is no mismatch uncertainty contribution in this relative accuracy test.

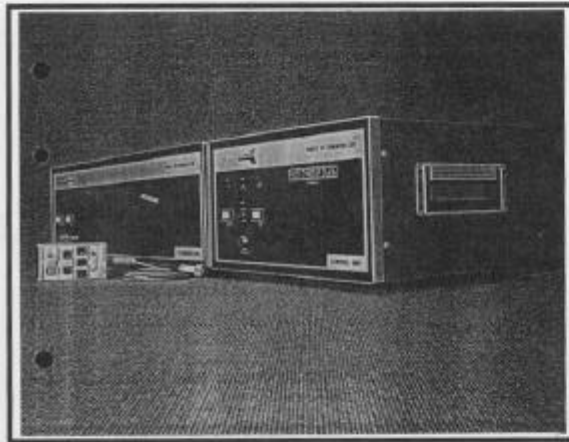

1772

Slide 46

This is the precision test attenuator in its controlled environment.

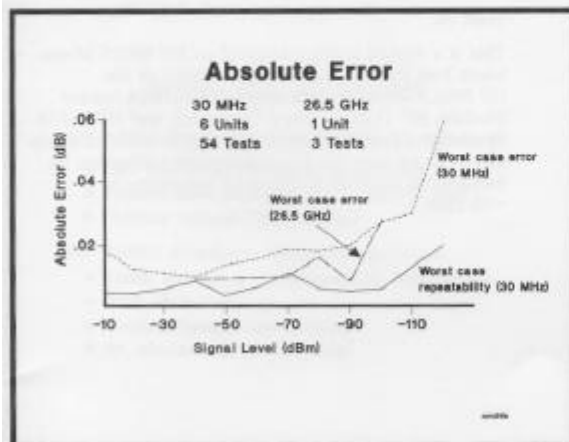

1773

Slide 47

This shows the results of the first group of HP 8902A's to be tested using the precision attenuator. Note the dramatic improvement over the standard data sheet specifications. This shows the inherent accuracy the HP 8902A is capable of achieving.

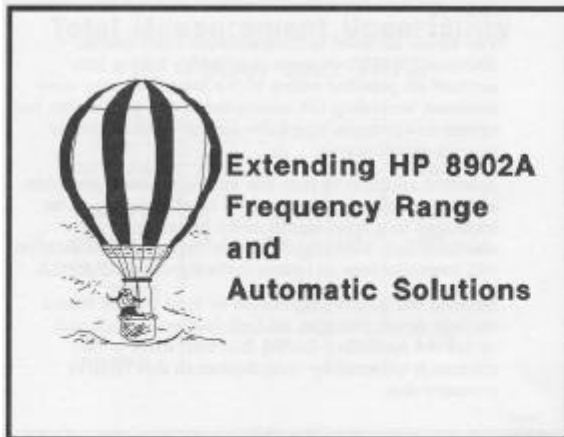

Slide 48

Extending HP 8902A Frequency Range and Automatic Solutions

1235

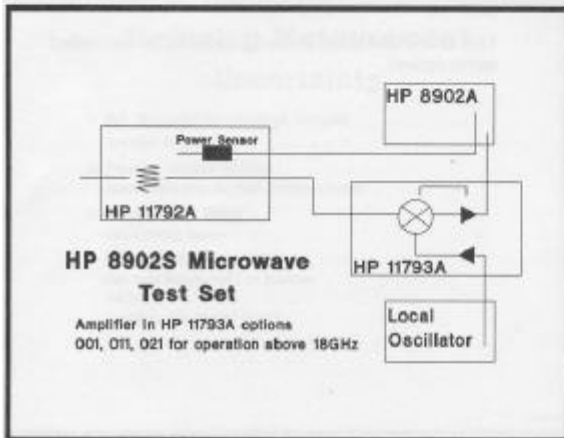

Slide 49

The basic frequency range of the HP 8902A Measuring Receiver is 1300 MHz. The excellent measurement accuracy of the HP 8902A can easily be extended to higher frequencies by simply adding an external down-conversion stage to mix microwave or millimeter-wave signals down to the range of the HP 8902A.

This is the block diagram of a typical microwave test system. The HP 11793A Down Converter contains a microwave mixer, 15 dB amplifier to compensate for mixer conversion loss, 800 MHz lowpass filter to minimize feedthrough, and optional 18 to 26.5 GHz microwave amplifier to compensate for local oscillators with insufficient output power. The HP 11793A also contains a microwave transfer switch so signals can either be down converted or passed directly through. With the HP 11792A Sensor Module, the system performs RF Power measurements from +30 dBm to -20 dBm at frequencies from 50 MHz to 26.5 GHz. To maximize SWR performance, the HP 11792A connects a 10 dB pad on the input. This minimizes the affects of changing complex impedance during calibration and measurement. The local oscillator used in the system should be synthesized and supply at least +8 dBm (or the optional microwave amplifier must be ordered).

For a properly configured system, the only additional instrumentation error is due to mixer compression for signals greater than -10 dBm. This error is negligible for signals less than -10 dBm.

631

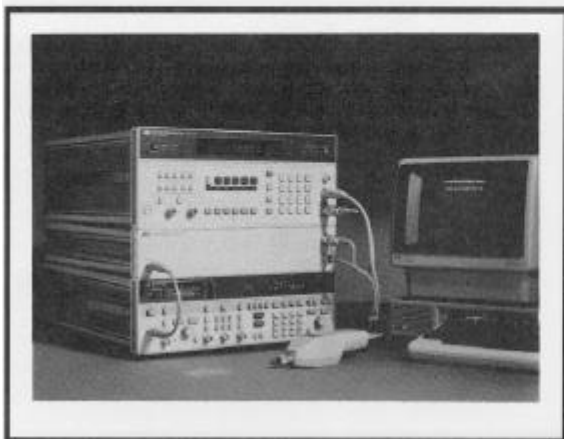

Slide 50

This is a typical configuration of an HP 8902S Microwave Test System. The system consists of the HP 8902A Measuring Receiver, HP 11792A Sensor Module, HP 11793A Down Converter, and HP 8673B Synthesizer local oscillator. This combination of equipment can be used for signal generator calibration for frequencies up to 26.5 GHz with sensitivity to -95 dBm.

630

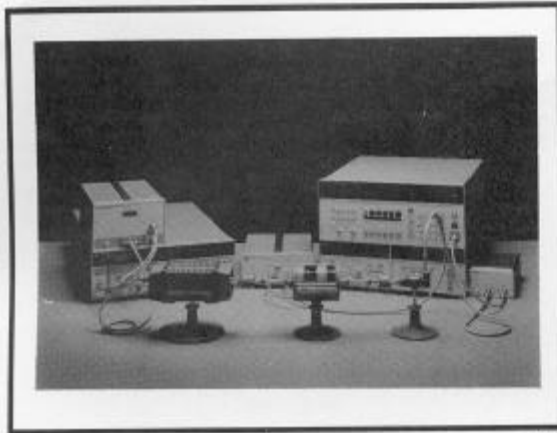

1099

HP 8902S TRFL Input Signal Range

Using HP 11792A

Frequency	Signal Range
< = 1000 MHz	+ 10 dBm to - 117 dBm
< = 18.0 GHz	+ 5 dBm to - 100 dBm
< = 26.5 GHz	+ 5 dBm to - 85 dBm

Using HP 11970A, U Harmonic Mixers

< = 60 GHz	- 10 dBm to - 160 dBm
------------	-----------------------

1236

AUTOMATIC SOLUTIONS

HP 11795A Signal Generator Calibration Software

- * Can Test Most HP Signal Generators
- * Follows Service Manual Performance Test
- * Flexible System Configuration

HP 11806A Attenuator Calibration Software

- * Fixed, Manual, or Programmable Attenuators
- * SWR Measurements
- * Flexible System Configuration
- * RF, Microwave, or Millimeter

1235

Slide 51

This is a typical configuration of a 40 GHz attenuator calibration system. The system uses an HP 8673B Synthesizer as the local oscillator to drive an HP 11970A Harmonic Mixer. The millimeter source driving the attenuator-under-test is a combination of an HP 8673B Synthesizer, HP 8349B Microwave Amplifier, and HP 83554A Millimeterwave Source Module.

The dynamic range and sensitivity of both the microwave and millimeter systems depends on the system configuration. Typically, either of these system can provide sensitivity to at least -95 dBm.

Slide 52

This table shows the input signal range for microwave and millimeter test systems. For a microwave system, the loss in sensitivity is primarily due to the insertion loss of the HP 11792A Sensor Module and 3 dB input attenuator and conversion loss of the mixer in the HP 11793A Down Converter. For a millimeter system, the loss in sensitivity is primarily due to the conversion loss of the harmonic mixers, matching attenuators, and/or isolators that may be configured in the system.

Slide 53

Software is available from Hewlett-Packard to perform both automatic signal generator calibration and attenuator calibration. Both of these easy-to-use, menu-driven software packages will run on either series 200 or 300 controllers. They offer very flexible instrument configurations, and various report formats. Both of these software packages will improve your efficiency by saving time and reducing errors.

The HP 11795A has options to test eight different Hewlett-Packard signal generators, both RF and microwave. These include models 8640B, 8656A, 8656B, 8642A/B, 8662A, 8663A, 8672A, 8673A/B/C/D/E/M. With optional equipment, pulse, phase noise, and spurious measurements are performed in some of the test packages.

The HP 11806A can easily test fixed, manual, or programmable stepped attenuators and can perform SWR tests if configured with an SWR bridge. The software supports RF, microwave, and millimeter instrument configurations. For best accuracy, the software also supports using a splitter and power sensor to monitor the power applied to the attenuator. This technique allows the system to correct for variations in the applied power which result from amplitude instabilities of the source that drives the attenuator.